

GB

Planet Super 4 f.S.

User Instructions



*The code of practice for the installation,
commissioning & servicing for central heating systems*

CERTIFICAZIONE
DEL SISTEMA DI
QUALITÀ AZIENDALE

ISO 9001
registered by



USER INSTRUCTIONS

VERY IMPORTANT!

PLEASE MAKE SURE YOUR LOG BOOK ENCLOSED IS FILLED IN CORRECTLY.
ALL CORGI REGISTERED INSTALLERS CARRY A CORGI ID CARD.
BOTH SHOULD BE RECORDED IN YOUR CENTRAL HEATING LOG BOOK.
YOU CAN CHECK YOUR INSTALLER IS CORGI REGISTERED
BY CALLING ON 01256 372300

LIGHTING AND OPERATION

BOILER IGNITION (fig. 1)

Open the gas cock, lower the cover of the control and activate the boiler by turning the selector knob to the summer (☀) position. When the green led (⓪) lights up, electricity is present in the boiler.

- With the selector knob on the summer (☀) position, the boiler works to take the temperature of the hot water to the

fixed value.

- With the selector knob on the winter position (❄) the boiler, once it has reached the temperature set on the heating potentiometer, will begin to modulate automatically in order to supply the system with the effective power requested. The boiler will stop functioning if the room stat or "Logica Remote Control" intercede.

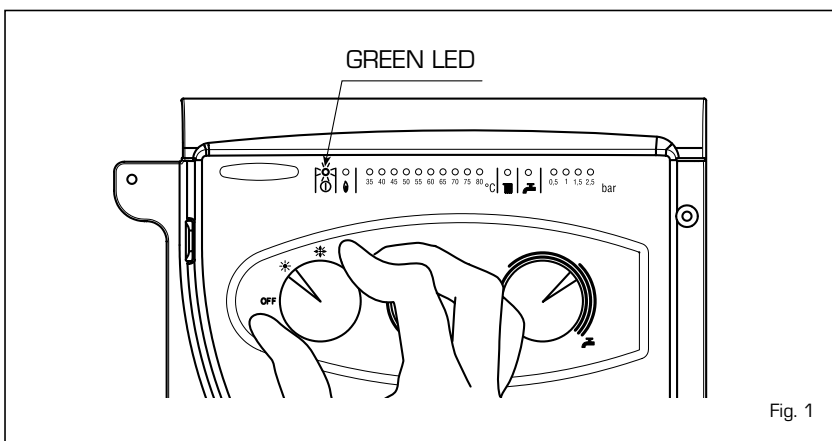

Fig. 1

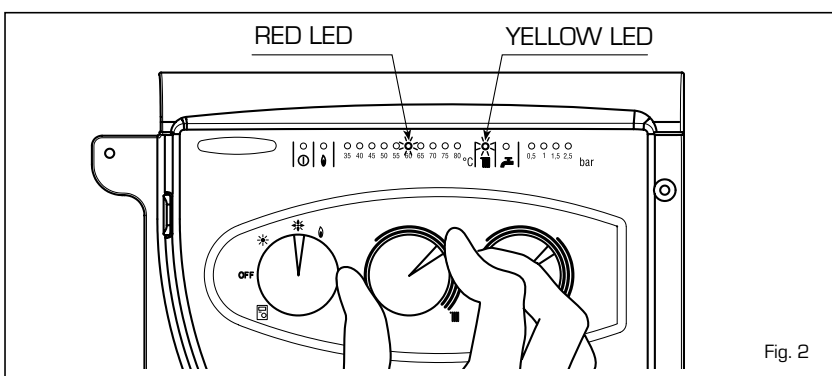

Fig. 2

TEMPERATURES ADJUSTMENT (fig. 2)

The panel of the red leds is graduated from 40÷80 °C and shows the temperature in the D.H.W. tank when the two service leds (Ⓜ) are off, it shows the temperature of the primary circuit when one of the two leds is lit up.

- Regulation of the D.H.W. temperature is carried out by acting on the hot-water service knob (Ⓜ). The set temperature is displayed on the scale of the red leds from 40 ÷80 °C.
 - Regulation of the C.H. temperature is carried out by acting on the heating knob (Ⓜ). The set temperature is shown on the scale of the red leds from 40÷80 °C.
- To guarantee an always optimal output from the generator it is advised not to go below a minimum operating temperature of 50 °C.

TURNING OFF BOILER (fig. 1)

To turn the boiler off place the selector knob on the **OFF** position.

IF THE BOILER IS NOT GOING TO BE USED FOR A LENGTHY PERIOD IT IS ADVISED TO TURN OFF THE ELECTRICITY SUPPLY, CLOSE THE GAS COCK, AND IF LOW TEMPERATURES ARE FORESEEN, EMPTY THE BOILER AND THE HYDRAULIC SYSTEM TO AVOID BREAKAGE IN THE TUBES DUE TO THE FREEZING OF THE WATER.

CLEANING AND MAINTENANCE

The programmed maintenance of the appliance must be carried out annually by authorised technical staff.

FAULTS FINDING

- **Ignition failure** (fig. 3)

If the burner fails to start the red led will light up (☹).

To attempt starting it again, the selector knob must be turned to the position (☹) and released soon after, returning to the summer (☼) or winter (❄) position.

If the failure should occur again, call the authorised technical staff for assistance.

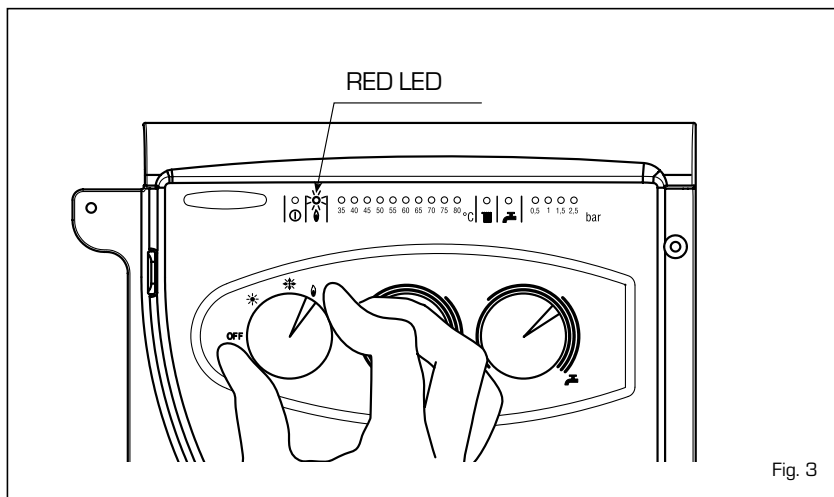

Fig. 3

- **Insufficient water pressure** (fig. 4)

If the red led "0.5 bar" intermittently lights up, the boiler is not functioning. To restore functioning act on the filling cock until the green led "1 bar" lights up.

Once filled close the filling tap.

If all the leds are off, call the authorised technical staff.

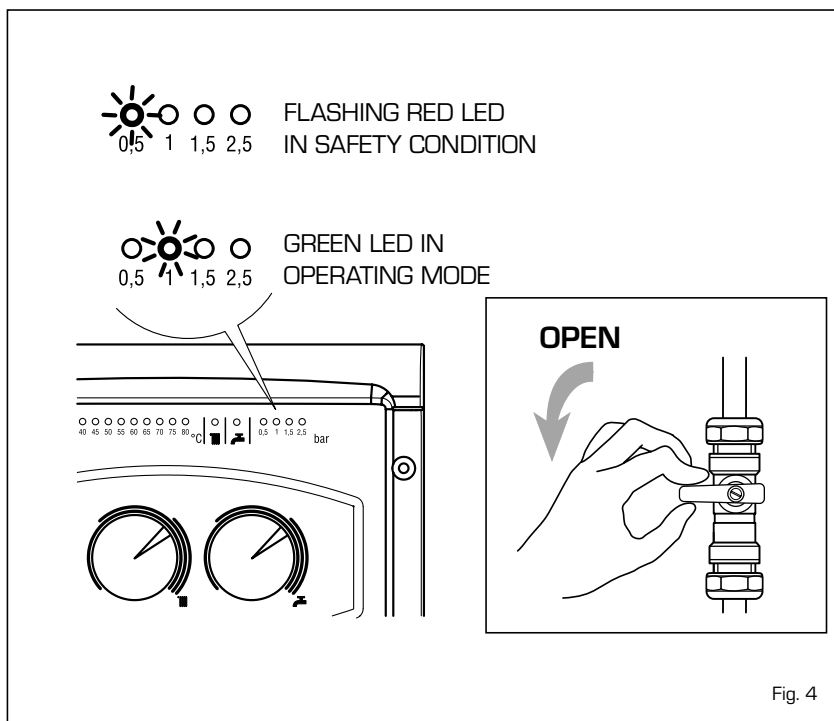

Fig. 4

- **Safety stat interception** (fig. 5)

If the safety stat intercedes the red led "35°C" intermittently lights up. To start the boiler again, turn the selector knob in the position (☹) and then release immediately, returning it to the winter (❄) or summer (☼) function.

If the failure should occur again, call the authorised technical staff for assistance.

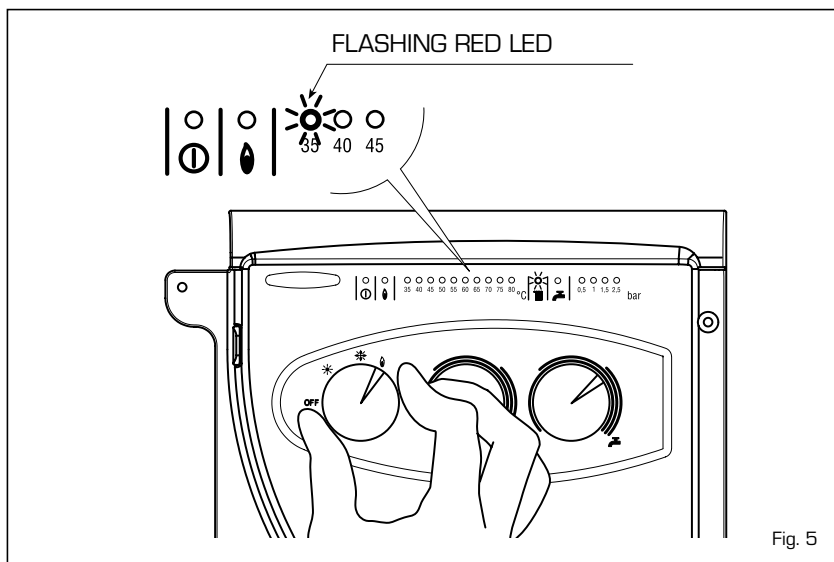

Fig. 5

- **Other faults** (fig. 6)

When one of the leds is flashing from "40÷ 80°C", deactivate the boiler and try to start it again. The operation may be repeated 2 or 3 times, and if there is no success call the authorised technical staff for assistance.

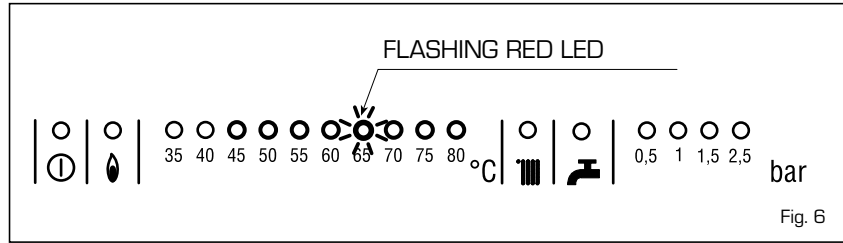

Fig. 6

MECHANICAL TIME CLOCK INSTRUCTIONS

Setting the time

Turn the clock dial in a clockwise direction until it reads the time of the day.

Program setting

Press inwards the segments on the program disk corresponding to the selected switching periods.

Function 1: segment set outwards (C.H. "ON")

Function 2: segment set inwards (C.H. "OFF")

Manual override

- 0 = "OFF" permanently
- ⊕ = automatic programmed operation
- 1 = "ON" permanently

Programming characteristics

Cycle	24 hour
Number of actions per cycle	96
Program time per segment	15 min.
Min. interval between two actions	15 min.

DIGITAL TIME CLOCK INSTRUCTIONS

When the selector is in the "AUTO" position, boiler functioning is automatically controlled on the basis of the temperature levels and time periods set. The second selector must be in the "RUN" position to start. The programming procedure is described below:

- **Setting the time**

Set the selector to the "⊕" position. Press "h" to change the hour on the display, or "m" to change the minutes. To set the day, press the "1...7" button until the arrow is pointing to the correct day (1 = Monday... 7 = Sunday).

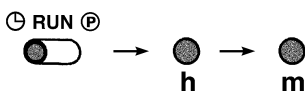

- **Setting the program**

The time clock has 8 on times and 8 off times. To make it easier to use, the time

clock is supplied with 3 on times and 3 off times already set for each day of the week, as shown below:

Program	Time	Temperature C°
1	06,00	20
2	09,00	14
3	12,00	20
4	14,00	14
5	18,00	20
6	22,00	14

Note: No program is set from 7 through 17

To select programmes other than those already set, move the selector to position "P"; "0:001" will appear on the display, in which the first three digits indicate the hour and minutes, while the fourth digit identifies the program number.

Odd-numbered programs identify requests for operation (day temperature), in which case the light bulb symbol will appear on the display, while even-numbered programs identify drops in temperature (night). Use the "1...7" key to select the day of the week (from 1 to 7) or days (1 ÷ 5, 6 - 7; 1 ÷ 6 or every day if the program is to be repeated every day of the week). Set the hour and minutes with the "h" and "m" buttons.

Press "P" to store the operation in memory and go on to the next program. Repeat the same procedure to set the remaining programs.

When finished programming, set the selector to "RUN" position.

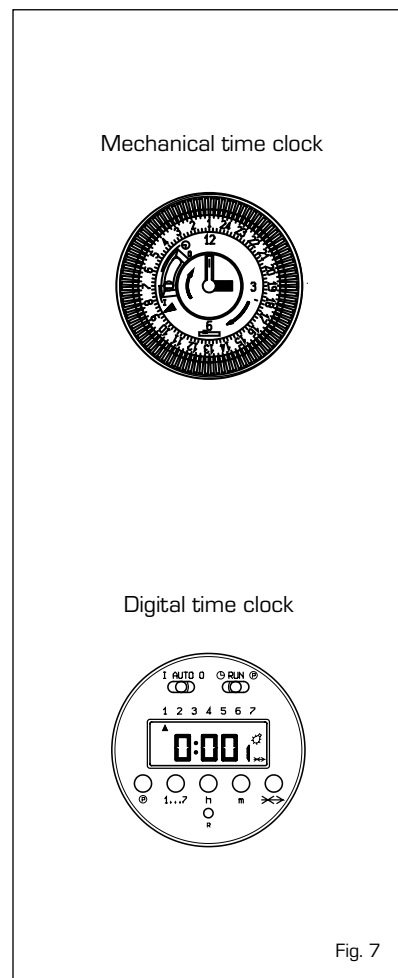
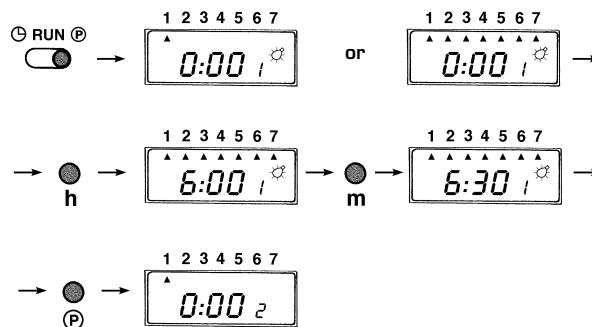

Fig. 7



- Deleting one or more programs (fig. 8)

The on and off time must be deleted for each program to be deleted.

Set selector (2) to position "P". Select the desired program with button (3), then press button (4) to delete the day setting (the triangular symbols for the days should go away). If part of the program is deleted, when you set selector (2) back to the "RUN" position an error will appear in the clock display, referring to the program which is incorrect.

To delete all programs, put the selector in position "P" and press buttons (3) and (5) at the same time.

- Setting the SKIP function (fig. 8)

The SKIP function deactivates programs for the next day and resumes regular programming 24 hours later.

This function is useful if you will be out all day and don't need heating. To start this function, press button (7), which is acti-

ve only when selector (2) is in "RUN" position.

Once you have selected the SKIP function, it will go into effect at 0:00 of the

next day for 24 hours. You cannot turn it off once it has started, so regular programming will not resume until 24 hours have passed.

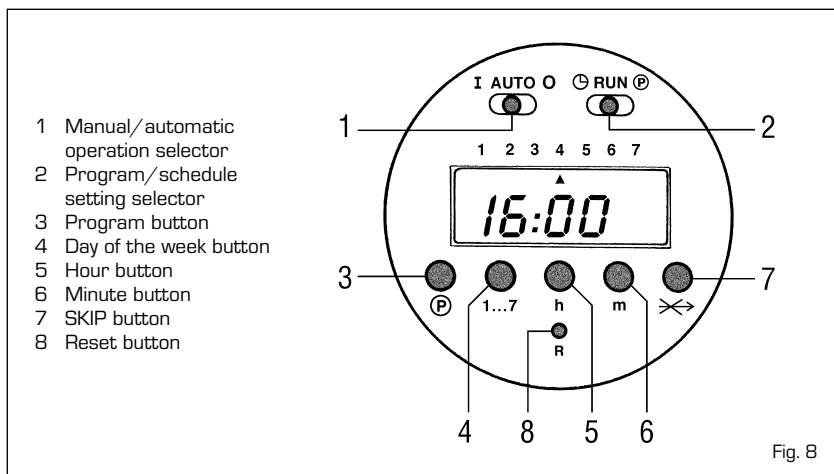

Fig. 8

LOGICA REMOTE CONTROL

When "PLANET SUPER 4 F.S." is connected to the "Logica Remote Control" regulator, the selector CR/OFF/EST/INV/UNBLOCK must be placed in the position (OFF); the knobs of the D.H.W. and C.H. potentiometers do not have any effect and all of the functions will be managed by the regulator (fig. 9).

If the "Logica Remote Control" breaks down, the boiler will function by placing the selector on the (☀ or ❄), position, obviously without consequent control of the room temperature.

The functioning instructions are inside the lid (fig. 10). Every setting or modification is displayed and confirmed on the display (fig. 11).

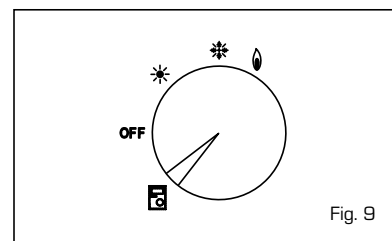

Fig. 9

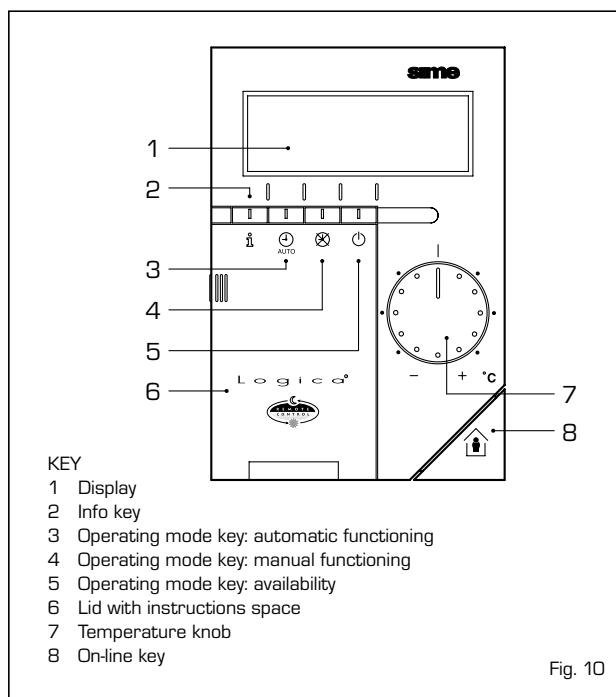
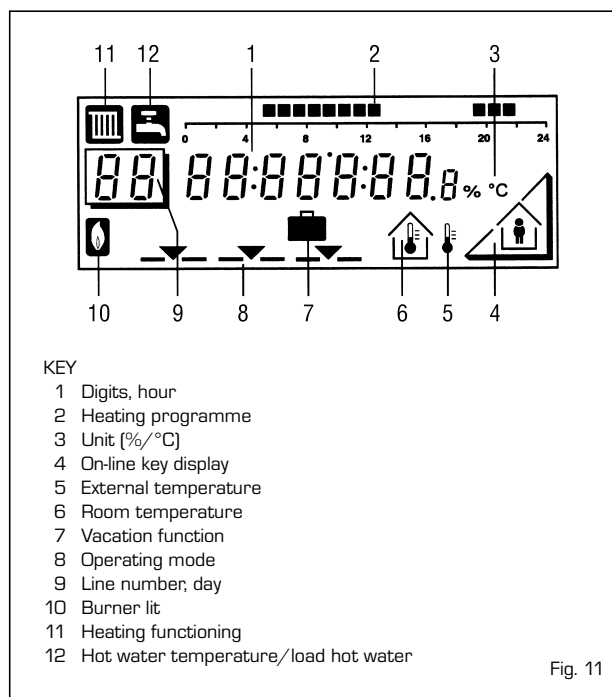

Fig. 10



KEY

- 1 Digits, hour
- 2 Heating programme
- 3 Unit (%/°C)
- 4 On-line key display
- 5 External temperature
- 6 Room temperature
- 7 Vacation function
- 8 Operating mode
- 9 Line number, day
- 10 Burner lit
- 11 Heating functioning
- 12 Hot water temperature/load hot water

Fig. 11

ACTIVATING

During operation the lid of the regulator must be closed.

- **Selection of the operating mode**
(reference keys grey colour)

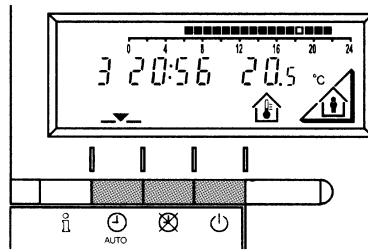

The operating mode desired is selected by pressing the relative key with the corresponding symbol. The choice is displayed with the symbol .



AUTO

Automatic functioning: the heating functions automatically according to the heating programme entered. The programme may be excluded for brief periods with the on-line key.



Manual functioning: the heating functions manually according to the choice made with the on-line key.



Availability: the heating is deactivated.

- **Info key**
(reference key grey colour)

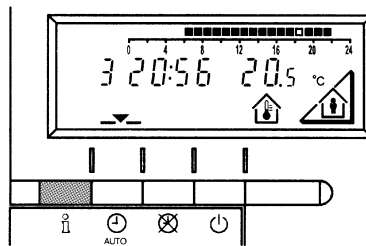

For every operation of the Info key the following list of items, one after the other, are displayed. The thermosensor continues to function independently of the display.



Day, hour, room temperature



External temperature*



D.H.W. temperature*

* This data appear only if the relative sensor is connected or if they are transmitted by the regulator of the boiler.

- **Adjusting the temperature**

Before adjusting the temperature of the regulator, the thermostatic valves, which may be present, have to be regulated to the desired temperature.

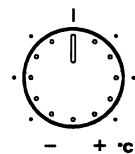

If it is too hot or too cold in your apartment, you can easily adjust the fixed temperature with the temperature knob.



If you turn the knob towards the + sign, the fixed temperature is increased by about 1 °C for every notch.



If you turn the knob towards the - sign, the fixed temperature is decreased by about 1 °C for every notch.

Before adjusting it again, however, allow the temperature to stabilise first.

Note: With the temperature knob you can only adjust the fixed temperature, whilst the reduced temperature remains the same.

- On-line key

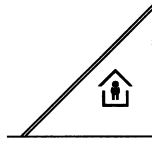

If the rooms remain unused for a long period of time, the temperature can be reduced with the on-line key, in this way saving energy. When the rooms are occupied again, press the on-line key to re-heat them. The current choice is displayed on the display:



Fixed temperature heating



Reduced temperature heating

NOTA: The choice made will work in a permanent way when manually carried out, instead, if automatic it will work up to the next switching according to the heating programme.

PROGRAMMING

For the programming the lid of the regulator must be open.

You can set or display the following values:

- Temperatures 1 up to 3
- Heating programme 4 up to 11
- Day of the week and hour 12 up to 14
- Current values 15 up to 17
- Vacation period 18
- Return to the default values 19

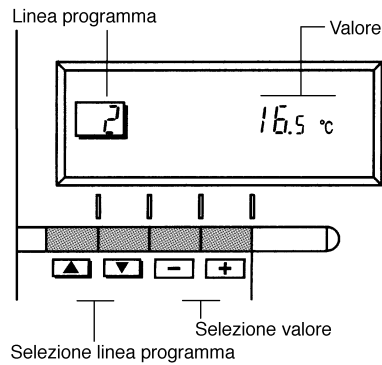

As soon as the cover is open, the display and the key functions are switched on. The number in the square represents the programme lines that may be selected with the arrow keys.

- Temperature regulation

Before proceeding with the adjustment in the temperature on the regulator, the thermostatic valves, which may be present, have to be regulated to the desired temperature.

In automatic mode, the apparatus switches from the fixed temperature to the reduced temperature according to the temporal programme. The manual switching of the temperature is done manually with the on-line key.



Fixed temperature: temperature when the rooms are occupied (basic setting)



Reduced temperature: temperature during periods of absence or night



Comfort D.H.W. temperature: desired temperature of domestic hot water



Reduced temperature of domestic hot water: temperature desired for domestic hot water at reduced level.

To have access to the "reduced D.H.W. temperature" parameter, press the and keys at the same time for at least 5 seconds and then go along the entered lines with the key until parameter 61 is reached. Regulate the value with and .

- Heating programme

With the heating programme it is possible to set the switching times of the temperature for a period of a week. The weekly programme consists of 7 daily programmes. One daily programme allows 3 phases of heating. Each phase is defined by a ignition time and a finishing time. The n° 8 daily programme is for the domestic hotwater service. If a phase is not required, the same ignition and finishing time may be entered.



- 4 Select the days that correspond with the heating phase.
1 = Monday, ... 7 = Sunday/8 = hot-water service programme
- 5 Start of phase 1: heating with fixed modality
- 6 End phase 1: heating with reduced modality
- 7 Start phase 2: heating with fixed modality
- 8 End phase 2: heating with reduced modality
- 9 Start phase 3: heating with fixed modality
- 10 End phase 3: heating with reduced modality
- 11 Copying of the daily programme

+ By pressing this key it is possible to repeat the current heating programme for the **next day**.

- By pressing this key it is possible to repeat the current heating programme for the **previous day**.

As a confirmation the following day is displayed.

- D.H.W. programme

With the Logica Remote Control it is possible to manage the temperature of D.H.W. tank on two levels (a comfort level and one at reduced temperature) in accordance with the programme chosen with parameter 62 (load domestic hot water). To have access to the parameter press the ▲ and ▼ keys for at least 5 seconds and then go along the entered lines with the ▼ key until parameter 62 is reached. At this point four different programmes may be selected with - or + keys, with the following characteristics:

0 = 24 hours/ day - Hot water is always available at the temperature set with user parameter n°3.

1 = standard - Hot water according to the daily heating programme.

In the comfort areas of heating the temperature of the D.H.W. tank is regulated to the value set with user parameter n° 3.

In the reduced areas of heating the temperature of the D.H.W. tank is regulated to the value set with parameter n° 61 of the service level.

2 = service disconnected

3 = second daily programme (8) - Every day of the week the temperature of the hot water is set according to programme 8. In this case there is a single programming for all the days of the week and three time zones are available. In the time spans set the temperature of the D.H.W. tank is regulated according to that set in parameter n°3. In the remaining hours the D.H.W. tank is controlled to the temperature set with parameter n° 61 the of service level.



- 5 Start phase 1: preparation of the D.H.W. tank to the comfort temperature
- 6 End phase 1: Temperature of D.H.W. tank maintained at the reduced value
- 7 Start phase 2: Preparation of D.H.W. tank to the comfort temperature
- 8 End phase 2: Temperature of D.H.W. tank maintained at the reduced value
- 9 Start phase 3: preparation of D.H.W. tank to the comfort temperature
- 10 End phase 3: Temperature of D.H.W. tank maintained at the reduced value

- **Setting the time**

12 To set the current day of the week
(1 = Monday/7 = Sunday)

13 To set the current hour



14 To set the current minute
Once the hour is completed, the setting of the hour changes.

With **+** and **-** keys the current hour is regulated. Pressing these keys together, the regulation is speeded up in an increasing sense.

- **Current values**

15 Display and setting of the gradient of the heating characteristics curve.
When the room temperature set is not reached choose the gradient indicated in point 2.10.3

16 Display of the current boiler temperature.

17 Display of the current power of the burner and of the current operating mode
( = heating/  = D.H.W. service)

- **Vacation function**

18 To enter the number of days of absence.

In the display the vacation symbol will be shown () , on the left the day of activation (1 = Monday/7 = Sunday) and on the right the number of vacation days.

NOTE:



During the vacation the regulator will be on the availability mode.



When the set days have elapsed, the regulator will go on to the automatic function.

AUTO

The vacation period may be cancelled by pressing a key of the operating mode.

- **Default values**

19 To take the setting to the default values, press the **+** and **-** keys at the same time for at least 3 seconds. As confirmation a sign will appear on the display.

ATTENTION

The values of the following line numbers previously entered will be lost.

• Temperature and time programme **1** to **10**

• Vacation period **18**

- **Display of the functioning faults on the display**

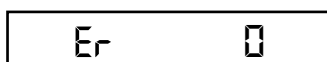

Ignition failure

Turn the selector CR/OFF/EST/INV/UNBLOCK on the "PLANET SUPER 4 F.S." control panel to the unblock position () to restore functioning (fig. 3). If the failure should occur again, call the authorised technical staff for assistance.



Safety stat interception

Turn the selector CR/OFF/EST/INV/UNBLOCK of the "PLANET SUPER 4 F.S." control panel to the unblock position () to restore functioning (fig. 5). If the failure should occur again, call the authorised technical staff for assistance.

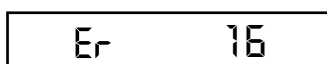

Smoke pressure switch failure

Call the authorised technical staff for assistance.

Er 66

Smoke pressure switch does not return to rest position
Call the authorised technical staff for assistance.

Er 67

D.H.W. sensor fault (SB)
Call the authorised technical staff for assistance.

Er 68

C.H. sensor fault (SM)
Call the authorised technical staff for assistance.

Er 69

Insufficient water pressure
Restore functioning by acting on the filling cock of the boiler (fig. 4)

Er 70

System overpressure
Call the authorised technical staff for assistance.

Er 192

Safety stat interception
Call the authorised technical staff for assistance.

Er 193

Smoke pressure switch interception
Call the authorised technical staff for assistance.

Er 194

Failure of the modulating coil
Call the authorised technical staff for assistance.

Er 195

Communication failure between the Logica Remote Control and the boiler
Call the authorised technical staff for assistance.



Sime Ltd

Unit D2 Enterprise Way, Bradford Road, Idle, Bradford BD10 8EW

Tel. 0870 9911114 - Fax 0870 9911115

www.sime.ltd.uk - e-mail: enquiries@sime.ltd.uk