

UK

ENSURE THAT THESE INSTRUCTIONS ARE LEFT  
FOR THE USER AFTER COMPLETION OF THE  
BENCHMARK SECTION



# BRAVA DGT HE

## *User instructions*



Please read the Important Notice within  
this guide regarding your boiler warranty



## **IMPORTANT NOTICE**

For the first year all of our appliances are protected by our manufacturer's guarantee which covers both parts and labour.

As you would expect from Sime Ltd, it is our aim to provide our valued customers with the best in after sales and service.

To take advantage of any extended warranty offered, all you have to do is to adhere to these 3 simple conditions:

- The installation must be carried out to Manufacturers/Benchmark Standards by a Gas Safe Registered Engineer, and recorded in the installation manual.
- The appliance must be registered with both Sime Ltd and Gas Safe within 30 days of installation.
- The appliance must be serviced annually, by either Sime Ltd or a Gas Safe registered engineer- ensuring that the Benchmark service record in the installation manual is completed.

Failure to comply with the above will result in only the 12 month warranty being offered.

In the absence of any proof of purchase, the 12 month warranty period will commence from the date of manufacture of the boiler as shown on the appliance data plate.

# Code Of Practice

For the installation, commissioning and servicing  
of domestic heating and hot water products

Benchmark places responsibilities on both manufacturers and installers.\* The purpose is to ensure that customers\*\* are provided with the correct equipment for their needs, that it is installed, commissioned and serviced in accordance with the manufacturer's instructions by competent persons and that it meets the requirements of the appropriate Building Regulations. Installers are required to carry out work in accordance with the following:

## Standards of Work

- Be competent and qualified to undertake the work required.
- Install, commission, service and use products in accordance with the manufacturer's instructions provided.
- Ensure that where there is responsibility for design work, the installation is correctly sized and fit for purpose.
- Meet the requirements of the appropriate Building Regulations. Where this involves notifiable work be a member of a Competent Persons Scheme or confirm that the customer has notified Local Authority Building Control (LABC), prior to work commencing.
- Complete all relevant sections of the Benchmark Checklist/Service Record when carrying out commissioning or servicing of a product or system.
- Ensure that the product or system is left in a safe condition and, whenever possible, in good working order.
- Highlight to the customer any remedial or improvement work identified during the course of commissioning or servicing work.
- Refer to the manufacturer's helpline where assistance is needed.
- Report product faults and concerns to the manufacturer in a timely manner.

## Customer Service

- Show the customer any identity card that is relevant to the work being carried out prior to commencement or on request.
- Give a full and clear explanation/demonstration of the product or system and its operation to the customer.
- Hand over the manufacturer's instructions, including the Benchmark Checklist, to the customer on completion of an installation.
- Obtain the customer's signature, on the Benchmark Checklist, to confirm satisfactory demonstration and receipt of manufacturer's instructions.
- Advise the customer that regular product servicing is needed, in line with manufacturers' recommendations, to ensure that safety and efficiency is maintained.
- Respond promptly to calls from a customer following completion of work, providing advice and assistance by phone and, if necessary, visiting the customer.
- Rectify any installation problems at no cost to the customer during the installer's guarantee period.



\*The use of the word "installer" is not limited to installation itself and covers those carrying out installation, commissioning and/or servicing of heating and hot water products, or the use of supporting products (such as water treatment or test equipment).

\*\*Customer includes householders, landlords and tenants.

## The Benchmark Scheme

Sime Ltd is a licensed member of the Benchmark Scheme which aims to improve the standards of installation and commissioning of domestic heating and hot water systems in the UK and to encourage regular servicing to optimise safety, efficiency and performance.

Benchmark is managed and promoted by the Heating and Hotwater Industry Council.  
For more information visit [www.centralheating.co.uk](http://www.centralheating.co.uk)

Please ensure that the installer has fully completed the Benchmark Checklist in the use and maintenance section of the installation instructions supplied with the product and that you have signed it to say that you have received a full and clear explanation of its operation.

The installer is legally required to complete a commissioning checklist as a means of complying with the appropriate Building Regulations (England and Wales).

All installations must be notified to Local Area Building Control either directly or through a Competent Persons Scheme.

A Building Regulations Compliance Certificate will then be issued to the customer who should, on receipt, write the Notification Number on the Benchmark Checklist.

This product should be serviced regularly to optimise its safety, efficiency and performance.

The service engineer should complete the relevant Service Record on the Benchmark Checklist after each service.

The Benchmark Checklist may be required in the event of any warranty work and as supporting documentation relating to home improvements in the optional documents section of the Home Information Pack.

# CONTENTS

## OPERATING INSTRUCTIONS FOR THE USER

1.1	INTRODUCTION .....	6
1.2	APPLIANCE OPERATION	
1.3	OPERATING INSTRUCTIONS	
1.4	ERRORS AND SOLUTIONS .....	7
1.5	MINIMUM CLEARANCES .....	8
1.6	ROUTINE SERVICING	
1.7	ELECTRICAL SUPPLY	
1.8	VENTILATION	
1.9	CLEANING	
1.10	SAFETY	
1.11	INSTRUCTIONS FOR OPTIONAL TIMER	
	SIME PART NUMBER 7102604 / BCG NUMBER 138493 .....	9
1.12	INSTRUCTIONS FOR PROGRAMMING CLOCK	

*Brava DGT HE 25: Gas Council number 47-283-38*

*Brava DGT HE 30: Gas Council number 47-283-39*

*Brava DGT HE 35: Gas Council number 47-283-40*

***These appliances comply with the S.E.D.B.U.K. scheme, band "A"***

### **VERY IMPORTANT!**

**All Gas Safe Registered installers carry a ID card.**

**You can confirm that your installer is registered by calling**

**Gas Safe Register on 0800 408 5577.**

**Please ensure that your installer has completed the Gas Boiler System**

**Commissioning Checklist in the installation guide.**

**It is a requirement of the warranty that your installer registers your**

**boiler installation with GAS SAFE REGISTER.**

**This should be no later than 30 days after installation.**

**You will receive a Buildings Regulations Compliance Certificate**

**(in Scotland a Declaration of Safety).**

**The certificate number must be recorded on the checklist.**

**It is also a condition of any extended warranty that the boiler is serviced**

**annually, and this is recorded in the Service Record.**

# OPERATING INSTRUCTIONS FOR THE USER

THE GAS SAFETY (INSTALLATION AND USE) REGULATIONS 1996. It is the law that all gas appliances are installed by a registered person, in accordance with the above regulations. Failure to install appliances correctly could lead to prosecution. It is in your own interest, and that of safety, to ensure that the law is complied with.

**It is essential that the appliance is correctly earthed. An electricity supply of 240 V - 50 Hz fused at 3 A is required.**

Read these instructions carefully before attempting to operate the appliance.

## 1.1 INTRODUCTION

The Sime **BRAVA DGT HE** family is a fully automatic, wall mounted, room sealed, fan assisted range of combination boilers.

When operating in winter mode, the appliance provides central heating as required and produces instantaneous hot water upon demand.

When operating in summer mode, the central heating is not operational however the appliance continues to supply hot water whenever it is required.

## 1.2 APPLIANCE OPERATION

A demand of hot water will be sensed by the appliance detecting water flow (providing that the flow rate is above 2 l/m - 0.5 gal/min).

The fan will start and the burner will

light at full output. If the draw off rate is near the maximum design flow rate the appliance will run continuously at full output until a tap is either turned off or the flow rate is reduced in which case the heat output will reduce accordingly to maintain a steady temperature.

Hot water is made available almost immediately at the appliance outlet, but the final temperature and time taken for the hot water to reach a tap depends upon the potentiometer setting, the rate at which water is drawn off, and the length of the pipe between the boiler and the tap.

When the tap is turned off, the appliance will revert to C.H. mode (if set on winter position) otherwise the burner will be extinguished pending the next demand for hot water.

## 1.3 OPERATING INSTRUCTIONS

### 1.3.1 Boiler ignition (fig. 1)

The first ignition of the boiler must be carried out by qualified technical personnel.

When it is necessary to restart the boiler follow this procedure:

- ensure that the gas supply is turned on.
- turn on the electrical supply, a green LED should illuminate. After a delay of 30 seconds the boiler should resume operation; if the green led is on, this indicates the presence of voltage.

**N.B.:** After a delay of 15 minutes (PAR 5 default setting) if non of the buttons are pressed the keypad will "lockup" to resume operation, press any of the keys for more than two seconds (the display will indicate one to four segments progressively before unlocking the controls).

### Winter

Press the key  of the controls to activate the winter mode functioning (heating and D.H.W.). The display will be as shown in the figure.



### Summer

Press the key  of the controls to activate the summer mode functioning (only the production D.H.W.). The display will be as shown in the figure.



### 1.3.2 Regulation C.H. temperature (fig. 2)

To set the temperature of the water for heating, press the key  of the controls. The display will be as shown in the figure. Change the values with the

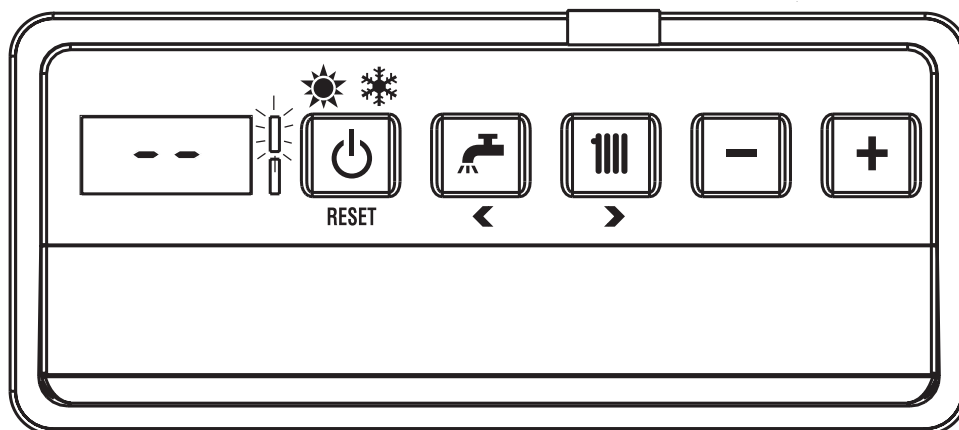

**ATTENTION:** Use the keys to alter the value of any function, a beep indicates that the change was accepted. The display will remain lit for 15 minutes (PAR 5 default).

Fig. 1

key [ - and + ]. Standard display will return by pressing the key III again, or after 60 seconds if no key is pressed. With a system water return temperature of less than 55 degrees, condensate will be produced, and the efficiency increased.

### 1.3.3 Regulation of the external sensor

If an external sensor is installed, the value of the output temperature is automatically chosen by the system, which quickly adjusts the of flow temperature on the basis of the external temperature.

If you wish to change the value of the temperature, increasing or decreasing that calculated automatically by the electronic card, proceed as indicated in 1.3.2. The level of various correction of a value of temperature proportional calculated. The display will be as shown.



Fig. 2

### 1.3.4 Regulation D.H.W. temperature (fig. 3)

To set the desired temperature D.H.W., press the key ⚡ of the controls. The display will be as shown in the figure. Change the values with the key [ - and + ].

The standard display will return by pressing the key ⚡ again, or after 10 seconds if no key is pressed.

### 1.3.5 To switch off the boiler (fig. 1)

In the case of a short absence, press for more than two seconds the key ⏻ of the controls. The display will be as shown in figure (boiler in stand-by). In this way, leaving the electricity and the gas supply connected, the boiler is protected from frost and from the pump becoming jammed.

If the boiler is not used for a prolonged period, it is advisable to disconnect the electricity supply, by switching off the main switch of the system, and to close the gas tap and, if low temperatures are expected, to completely drain the hydraulic circuits to avoid pipes being damaged from frost.

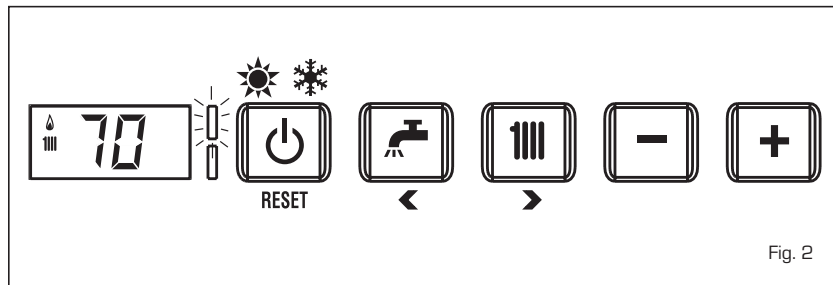

Fig. 3

## 1.4 ERRORS AND SOLUTIONS

When there is a functioning error, the display controls shows **a red LED**. Descriptions of the errors with the relative alarms and solutions are given below:

### - AL 02 (fig. 5)

If the water pressure detected is lower than 0.5 bar, the boiler will stop and the display will show "AL 02". Using the external filling device, bring the system pressure back to

normal so that the pressure indicated by the hydrometer (fig 5) is between 1 and 1.5 bar.

WHEN FILLING HAS BEEN COMPLETED CLOSE THE CONNECTIONS OF THE FILLING LOOP AND DISCONNECT IT.

If it necessary to repeat the system refilling procedure, it advisable to contact a qualified technical personnel to check the seal of the heating system (to check whether there are any leaks).

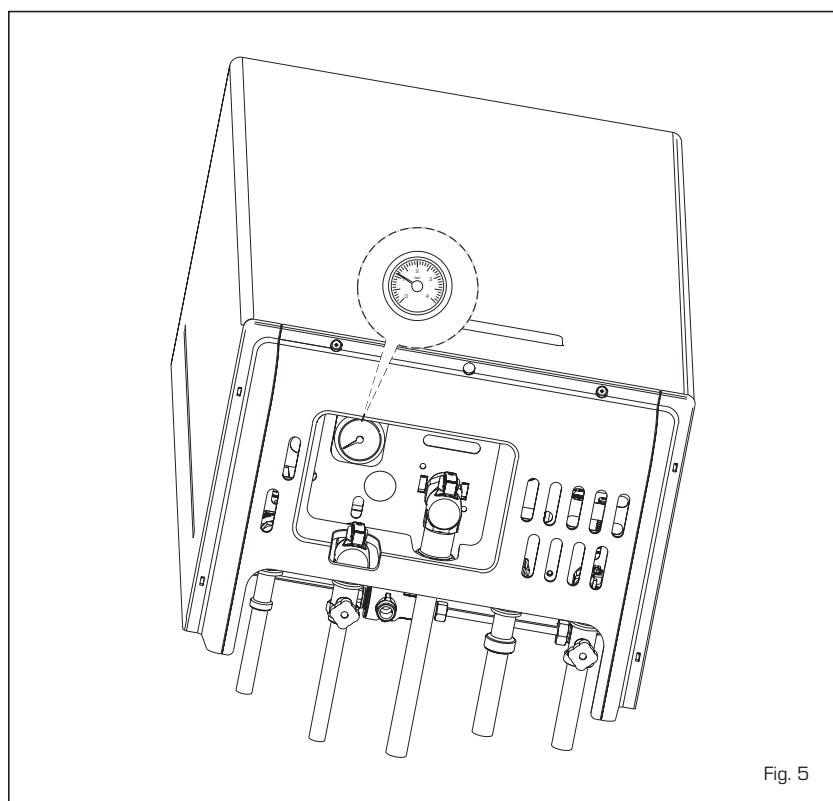

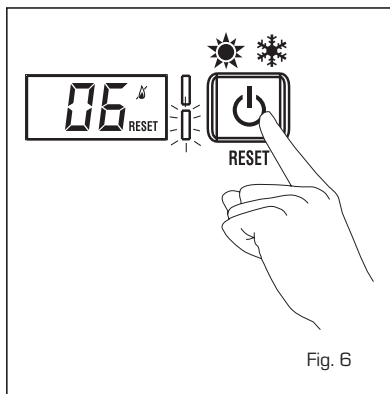



Fig. 5

- AL 05  
Request assistance from qualified technical personnel.

- AL 06 (fig. 6)  
Press the key  of the controls to re-start the boiler.  
If the error persists, request assistance from qualified technical personnel.



- AL 07 (fig. 7)  
Press the key  of the controls to re-start the boiler.  
If the error persists, request assistance from qualified technical personnel.

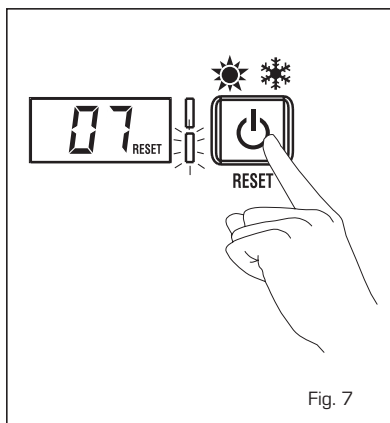

- AL 08  
Request assistance from qualified technical personnel.

- AL 10  
Request assistance from qualified technical personnel.

- AL 13 (fig. 8)  
Press the key  of the controls to re-start the boiler.  
If the error persists, request assistance from qualified technical personnel.

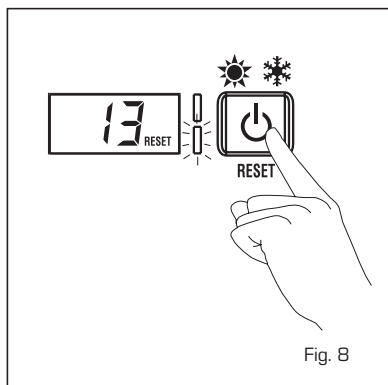

- AL 14  
Request assistance from qualified technical personnel.

- AL 15  
Request assistance from qualified technical personnel.

## 1.5 MINIMUM CLEARANCES

The following MINIMUM CLEARANCES must be available for servicing the appliance:

	For servicing
ABOVE THE APPLIANCE CASING	300 mm
AT THE R.H.S.	15 mm
AT THE L.H.S.	15 mm
BELOW THE APPLIANCE CASING	200 mm
IN FRONT OF THE APPLIANCE	500 mm

## 1.6 ROUTINE SERVICING

To comply with the conditions of any extended warranty offered and to ensure continued safe and efficient operation, the boiler must be serviced at regular intervals, at least once a year.

This service must be recorded in the Benchmark section of this manual.

It is the law that any service work must be carried out by a Gas Safe Register registered engineer.

## 1.7 ELECTRICAL SUPPLY

THIS APPLIANCE MUST BE EARTHED. The mains supply must be fused at 3 amp.

## 1.8 VENTILATION

If the appliance is installed in a cabinet,

the cabinet MUST NOT be used for storage purposes.

Any ventilation provided for the appliance during installation MUST NOT be blocked and a periodic check must be made to ensure that the vents are free from obstructions.

## 1.9 CLEANING

Use only a damp cloth and mild detergent to clean the appliance outer casing. DO NOT use abrasive cleaners.

## 1.10 SAFETY

It is essential that the instructions in this booklet are strictly followed for the safe and economical operation of this appliance.

The appliance functions as a fan assisted balanced flue unit. The flue terminal MUST NOT BE OBSTRUCTED under any circumstances.

If damaged, turn off the appliance and consult the installer, service engineer, or gas supplier. If it is known or suspected that a fault exists on the appliance it MUST NOT be used until the fault has been rectified by a competent person.

**WARNING:**  
IF A GAS LEAK IS SUSPECTED OR EXISTS, TURN OFF THE GAS SUPPLY TO THE APPLIANCE AT THE GAS SERVICE COCK.

**DO NOT OPERATE ANY ELECTRICAL SWITCHES.**

**DO NOT OPERATE ANY ELECTRICAL APPLIANCE.**

**OPEN ALL WINDOWS AND DOORS. DO NOT SMOKE.**

**EXTINGUISH ALL NAKED LIGHTS. CONTACT THE NATIONAL GAS EMERGENCY SERVICE IMMEDIATELY ON 0800111999.**

## 1.11 INSTRUCTIONS FOR OPTIONAL TIMER SIME PART NUMBER 7102604/ BCG NUMBER 138493 (fig. 10)

### Normal Time Mode











The display shows the room temperature. If the batteries are low the  will be flashing. The old batteries must be replaced.

The anti freeze function is activated with  on the display when the temperature detected is 5°C or below.



Below 0°C the display will show **LO**.  
Above 40°C the display will show **HI**.

### Normal Time Setting Mode





Press , the Day of the Week 1-7 will flash (1=Monday). Press  or  to select the current day of the week.  
Press , the Hour will flash. Press  or  to set the hour.  
Press , the Minute will flash. Press  or  to set the minute.  
Press  to confirm the settings and return to normal mode (the display will automatically return to normal after 10 seconds)



### Factory Defined Programs

The heating will be turned on according to the activated program and the control temperature setting. When the heating is ON the program number and  icon are shown. The pre-defined programs are as shown:

	Mon-Fri	Sat or Sun
P1	06:00 (21°C)	08:00 (21°C)
P2	08:00 (16°C)	10:00 (16°C)
P3	12:00 (21°C)	12:00 (21°C)
P4	15:00 (16°C)	15:00 (16°C)
P5	18:00 (21°C)	18:00 (21°C)
P6	23:00 (21°C)	23:00 (21°C)

The factory defined program can be adjusted to suit your personal requirements.

Press **PRG**, the hour will flash. Press  or  to change the hour setting.  
Press **PRG**, the minute will flash. Press  or  to change the minute setting.

Press **PRG**, the temperature will flash. Press  or  to change the temperature setting.

The program setting sequence is  
Mon-Fri (P1-P2-P3-P4-P5-P6)  
Sat (P1-P2-P3-P4-P5-P6)  
Sun (P1-P2-P3-P4-P5-P6).

Press  to confirm the settings and return to normal mode (the display will automatically return to normal after 10 seconds)

### Temporary / Permanent Override Mode

There are two override modes, Temporary and Permanent. The sequence is Normal-Temporary-Permanent.



The Temporary override mode maintains the room temperature at the override temperature until the next program time is met.



The Permanent override mode maintains the room temperature at the override temperature until the over-



Fig. 10



ride mode is released.

To select the override option press , the mode changes from Normal to Temporary override mode and the  icon will be displayed.



Press the  again, the mode changes from Temporary override mode to Permanent override mode, and the  icon will be displayed.

Press the  again, the mode changes from Permanent override mode to normal mode.

### Review and adjust the Override temperature

Press the  or , the override temperature is shown.

Hold the  or  for more than 2 seconds, the override temperature will flash.

Press the  or  to adjust the override temperature.

Press  to confirm the settings and return to normal mode (the display will automatically return to normal after 10 seconds)

The adjusted override temperature is accepted, and the display shows the actual temperature.

### Control Off / Sleep Mode

Press  to select the sleep or control off mode.

The sequence is Normal-Sleep-Control Off-Normal Mode.

Sleep Mode  is displayed, the time is displayed, the temperature is being measured but not controlled, the central heating is turned off.

Control Off Mode- the display is fully turned off, the central heating is turned off.

Press any key to return to Normal mode.

**1.12 INSTRUCTIONS FOR PROGRAMMING CLOCK (fig. 11)**

**Setting the time**

The time of day can be set by grasping the outer edge of the black dial and turning it in a clockwise direction until the correct time is in line with the white pointer.

**Setting the "switching time"**

The "ON" periods are set by sliding the blue tappets, adjacent to the time periods required, to the outer edge of the dial. The tappets that remain at the centre of the dial will be the "OFF" periods.

**N.B.: The smallest switching time (ON or OFF) is 15 minutes.**

- To select "Timed" mode move the selector switch in the middle of the

clock face to the "⌚" position (middle of the slot).

- To select "Constant" mode move the selector switch in the middle of the clock face to the "I" position (bottom of the slot).
- To select "OFF" mode move the selector switch in the middle of the clock face to the "O" position (top of the slot).

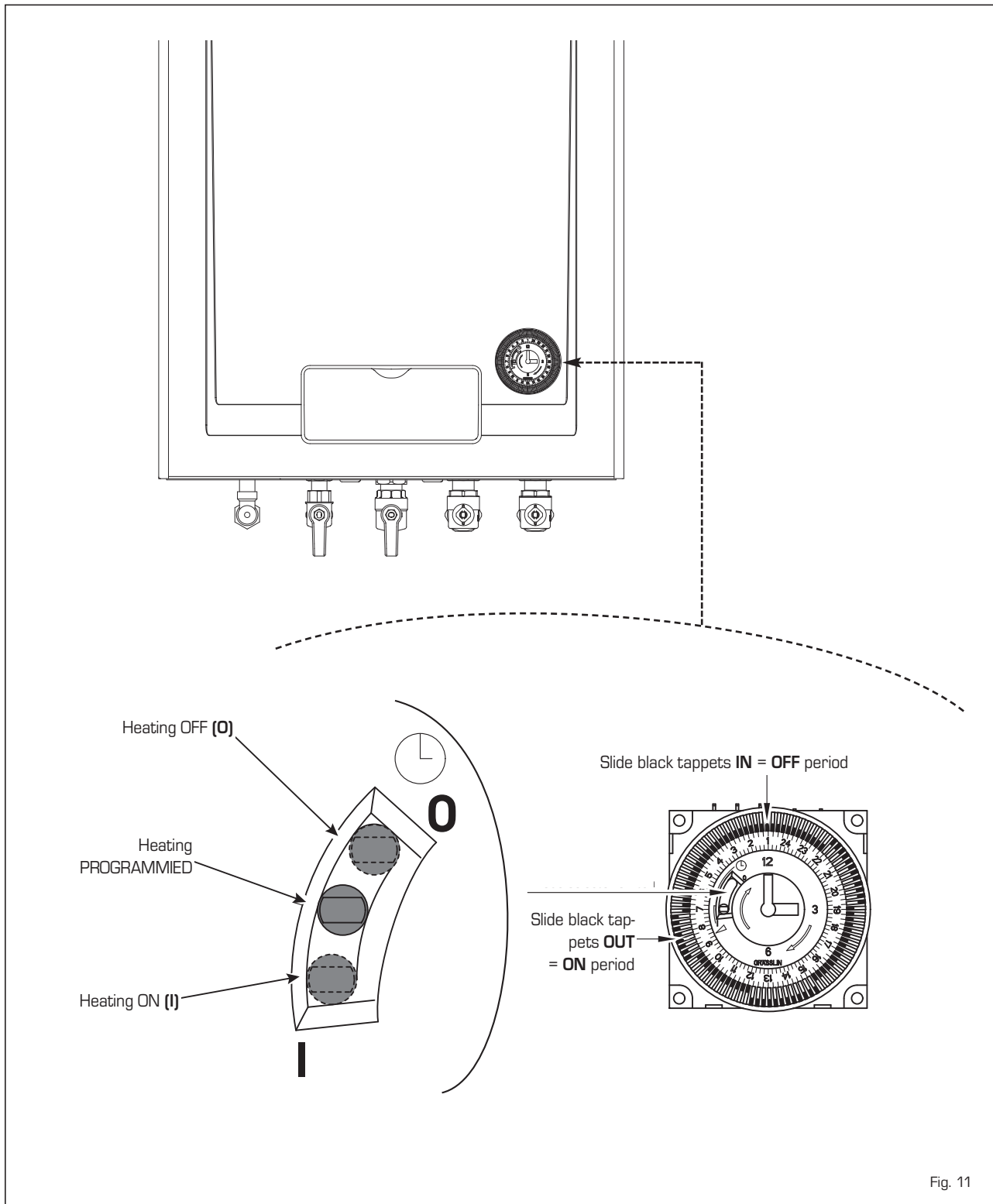

Fig. 11





**Sime Ltd**

1a Blue Ridge Park  
Thunderhead Ridge  
Glasshoughton, Castleford, WF10 4UA

Phone: 0845 9011114

Fax: 0845 9011115

[www.sime.co.uk](http://www.sime.co.uk)

Email: [enquiries@sime.co.uk](mailto:enquiries@sime.co.uk)